

ICOM

INSTRUCTION MANUAL

VHF FM TRANSCEIVER

IC-H16

UHF FM TRANSCEIVER

IC-U16

UHF FM TRANSCEIVER

IC-U2

Icom Inc.

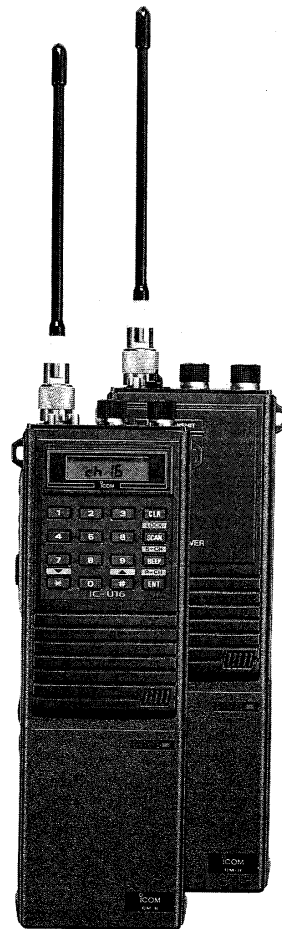

TABLE OF CONTENTS

SECTION 1	FEATURES	1
SECTION 2	ACCESSORIES (INCLUDED).....	3
SECTION 3	CONTROL FUNCTIONS (IC-U2).....	4
SECTION 4	CONTROL FUNCTIONS (IC-H16 AND IC-U16).....	12
SECTION 5	GENERAL SPECIFICATIONS	31
SECTION 6	ACCESSORIES (OPTIONAL).....	33

SECTION 1 FEATURES

- 1. MICROCIRCUIT TECHNOLOGY**

Employing an on-board, high-technology microcomputer, the IC-H16, IC-U16 and IC-U2 provide the maximum number of features for flexibility in addition to uncompromising performance and reliability in one compact package.
- 2. 16 SYNTHESIZED CHANNELS**

Incorporating a unique data entry system, the IC-H16/IC-U16 can store up to 16 channels in memory with any combination of duplex or simplex frequencies. Because it is synthesized, there is never any need to purchase costly crystals for channel changes.
- 3. FREQUENCY PROGRAMMING**

Incorporated in the IC-U2 is a sophisticated programming system which allows the programmed frequencies to be changed at any time or new frequencies to be added without changing crystals. (Contact your supplier for further details.)
- 4. POWER SAVER**

Incorporated in the IC-H16, IC-U16 and IC-U2 is a unique POWER SAVER circuit which places the radio in a "sleep" condition to conserve battery life when no signals are received or transmitted.
- 5. RUGGED CONSTRUCTION**

Constructed with an all metal chassis, stainless steel battery slide rails, reinforced die-cast aluminum back as well as moisture and dust resistant seals, the IC-H16, IC-U16 and IC-U2 are built to stand up to the most demanding environments.

6. SCANNING

The IC-H16 and IC-U16 can scan all programmed channels and will stop on received signals. Specific channels which you may not wish to scan can be deleted from the scanning sequence. Additionally, one channel can be given priority status and signals received on this channel would therefore be monitored regardless of other busy channels.

7. CTCSS ENCODER/DECODER

Up to 37 independent transmit and receive CTCSS tones can be programmed into the 16 memory channels allowing maximum flexibility for use on many repeater systems.

8. LCD READOUT

The multifunction, easy-to-read liquid-crystal display indicates the channel number and channel scanning order in addition to TX, RX, TONE, LOCK and CALL annunciators. A backlight is provided for viewing in low light conditions.

9. DTMF TONE GENERATOR

Included with the IC-H16 and IC-U16 is a DTMF circuit that generates the standard telephone dial tones. This circuit is controlled from the front panel keyboard.

10. SLIDE-ON BATTERY

The optional extra high-capacity, rechargeable nickel cadmium battery pack slides on or off the IC-H16, IC-U16 and IC-U2 for easy removal or installation. A one button quick release lock is provided to prevent unwanted removal.

SECTION 2 ACCESSORIES

UNPACKING

Carefully remove your transceiver from the packing carton and examine it for signs of shipping damage. Notify the delivering carrier or dealer immediately, stating full details, should any damage be apparent. We recommend you keep the shipping carton for storing, moving or reshipping the transceiver if necessary. Accessory hardware, cables, etc., are packed with the transceiver. Make sure you have removed all equipment and parts before discarding the packing material.

Accessories included with the IC-H16, IC-U16 and IC-U2:

	QTY.
Flexible antenna*	1
Belt clip	1
Belt clip screws	2
Belt clip plastic washers	2
Earphone.	1
Handstrap	1
External speaker plug.	1
External microphone plug	1
Rainproof cap	1
DC power plug	1

* Both VHF and UHF antennas shown. One antenna per transceiver supplied.

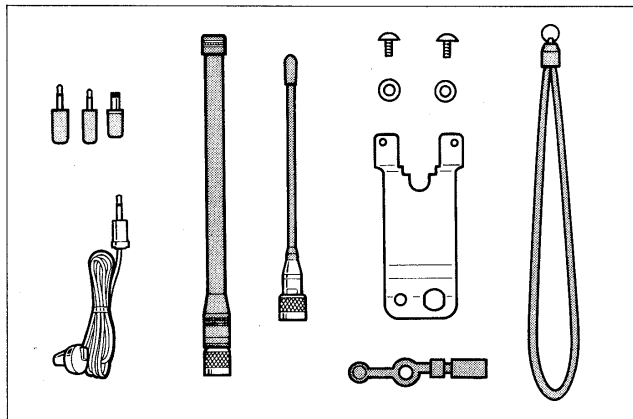

SECTION 3 CONTROL FUNCTIONS (IC-U2)



UHF FM TRANSCEIVER

IC-U2

CONTROL FUNCTIONS

For IC-H16 and IC-U16 see SECTION 4

Charger Connections

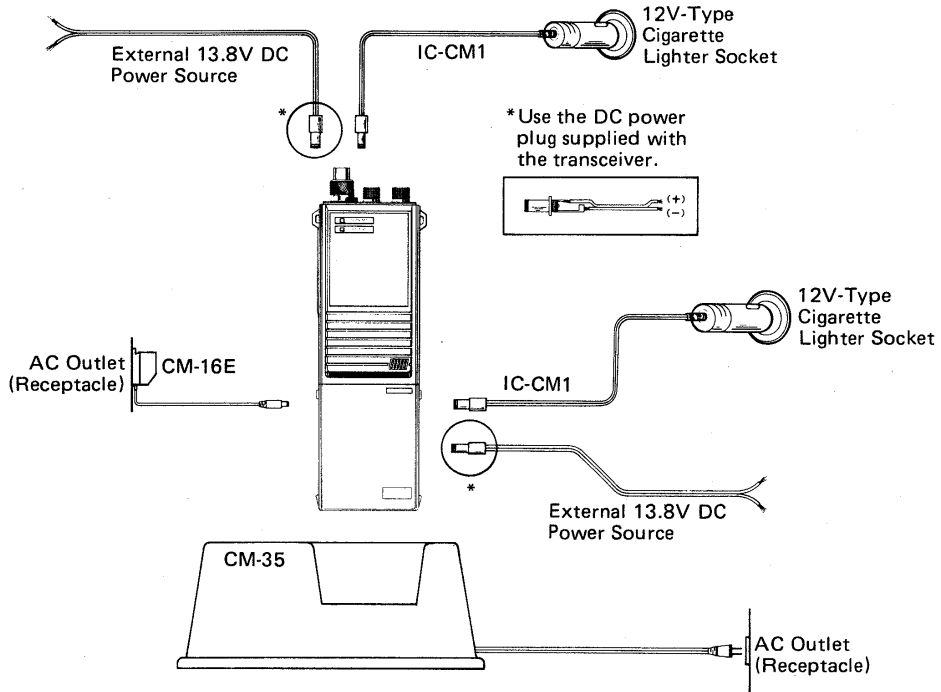

● **ANTENNA CONNECTION**

Insert the connector on the flexible rubber antenna into the antenna connector on the top of the transceiver. Screw down securely.

● **BELT CLIP INSTALLATION**

Attach the belt clip to the back panel using the two supplied screws and plastic washers.

● **HAND STRAP ATTACHMENT**

Spread open and slide the ring of the hand strap over either of the projecting loops on the sides of the transceiver.

● **ATTACHMENT OF BELT CLIP AND HAND STRAP**

- Attach the belt clip on the back panel with 2 screws supplied.

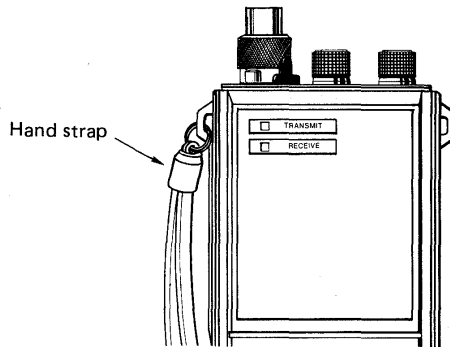
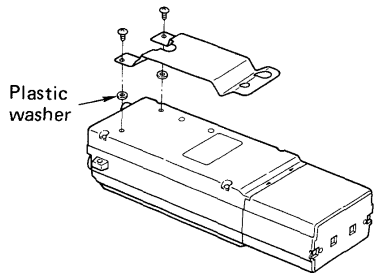

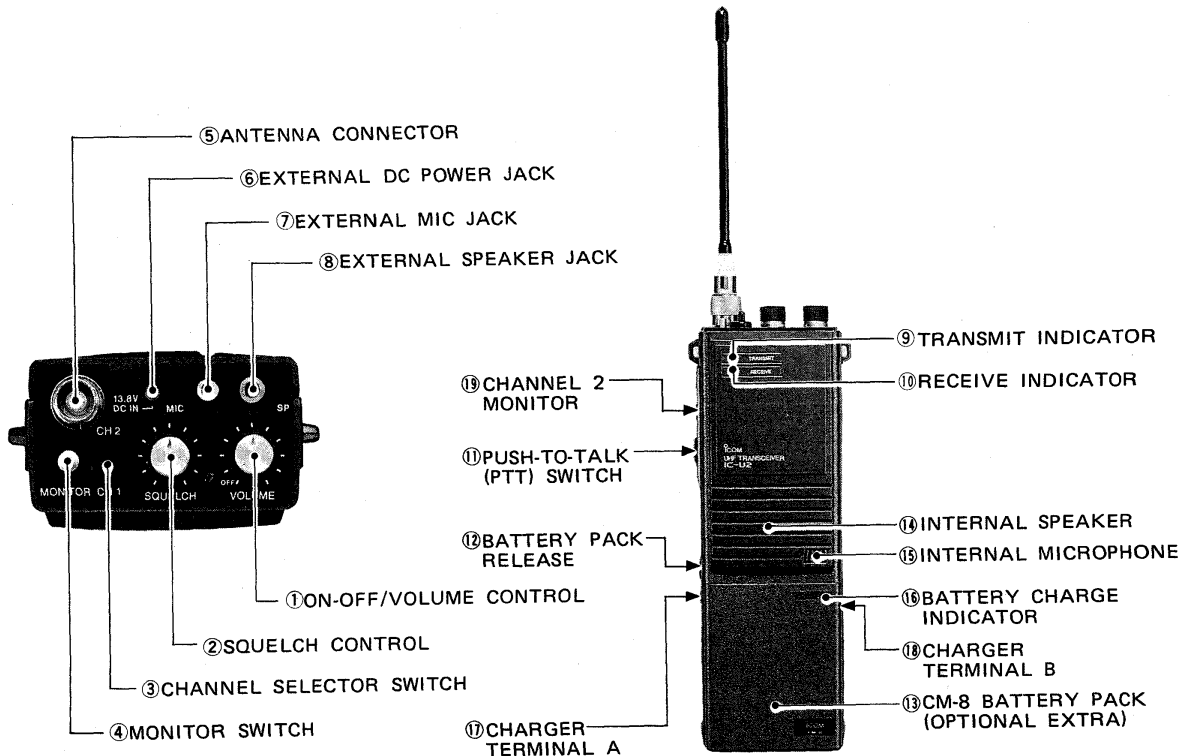

① ON-OFF/VOLUME CONTROL

Increases the audio level.



Rotate clockwise to turn the transceiver ON and increase the audio level.

② SQUELCH CONTROL

Raises the threshold level.

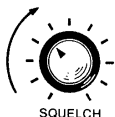

Sets the squelch threshold level. Rotate this control completely counterclockwise to turn OFF the squelch function, and clockwise to raise the threshold level.

③ CHANNEL SELECTOR SWITCH

This switch selects Channel 1 (CH1) or Channel 2 (CH2).

④ MONITOR SWITCH

Push IN this lock switch in order to override the CTCSS decoder circuit when it is in the mute condition. For normal operation, leave the switch OUT (push again and release).

⑤ ANTENNA CONNECTOR

All antennas connected to the transceiver must be 50Ω and should be equipped with a TNC plug.

CAUTION: Transmitting without an antenna may damage the transceiver.

⑥ EXTERNAL DC POWER JACK

Connect the IC-CM1 CIGARETTE LIGHTER CABLE or external 13.8V DC power source to this jack for mobile operation. The battery pack does not need to be attached for operation of the transceiver. However, if the battery pack is attached, it charges simultaneously.

⑦ EXTERNAL MIC JACK



CM-9

The optional CM-9 or EM-46 SPEAKER-MICROPHONE, optional HS-10 HEADSET can be connected for additional flexibility. (The HS-10 requires the HS-10SA VOX unit or the HS-10SB PTT SWITCH BOX). The built-in microphone is not functional when an external microphone is connected.

⑧ EXTERNAL SPEAKER JACK

Connect either an 8Ω external speaker or the supplied earphone for private listening.

⑨ TRANSMIT INDICATOR

This indicator lights up when the transceiver is in the transmit mode.

⑩ RECEIVE INDICATOR

This indicator lights up when the transceiver is in the receive mode.

⑪ PUSH-TO-TALK (PTT) SWITCH

Push this switch to begin transmitting.

⑫ BATTERY PACK RELEASE BUTTON

Push the release button upwards, and slide the battery pack to the right to remove it from the IC-U2.

- ⑬ **CM-8 BATTERY PACK** The CM-8 is a fully rechargeable NiCd battery pack that easily connects to the IC-U2. (Optional extra)
- ⑭ **INTERNAL SPEAKER** The IC-U2's internal speaker will operate when the transceiver is receiving. However, it will not operate if an external speaker is connected to the EXTERNAL SPEAKER JACK.
- ⑮ **INTERNAL MICROPHONE** The IC-U2's internal microphone will operate when the transceiver is transmitting. However, it will not operate if an external microphone is connected to the EXTERNAL MICROPHONE JACK.
- For high performance operation using an external microphone, the optional CM-9 or EM-46 SPEAKER-MICROPHONE is recommended.
- ⑯ **BATTERY CHARGE INDICATOR** Lights up during battery charging with the optional CM-16E WALL CHARGER.
- ⑰ **CHARGER TERMINAL A** Connects the output plug from the optional CM-16E WALL CHARGER here.
- ⑱ **CHARGER TERMINAL B** Connects the output plug from an external 13.8V DC power source here.
- ⑲ **CHANNEL 2 MONITOR** Push this switch to monitor channel 2 when receiving on channel 1.

●RECEIVING

- 1) Rotate the ON-OFF/VOLUME CONTROL clockwise to turn the power ON.
- 2) Rotate the SQUELCH CONTROL fully counterclockwise and then push IN the MONITOR SWITCH.
- 3) Adjust the ON-OFF/VOLUME CONTROL to a comfortable listening level.
- 4) Rotate the SQUELCH CONTROL clockwise until the noise is quieted. This is the threshold point where signals can be received.
- 5) Push OUT the MONITOR SWITCH to turn ON the monitor function.
- 6) Set the CHANNEL SELECTOR SWITCH to select the desired channel.

●TRANSMITTING

- 1) Hold IN the PTT SWITCH (now the transceiver is in the transmit mode) and then speak into the microphone using your normal voice level.
- 2) Release the PTT SWITCH to return to the receive mode.

SECTION 4 CONTROL FUNCTIONS (IC-H16 AND IC-U16)

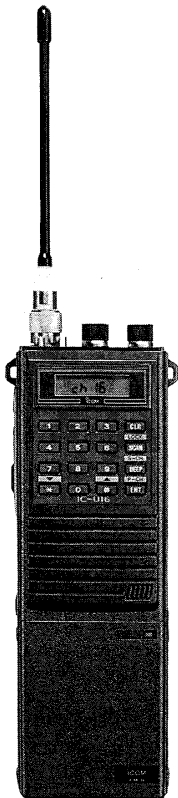

VHF FM TRANSCEIVER

IC-H16

UHF FM TRANSCEIVER

IC-U16

CONTROL FUNCTIONS

For IC-U2 see SECTION 3

Charger Connections

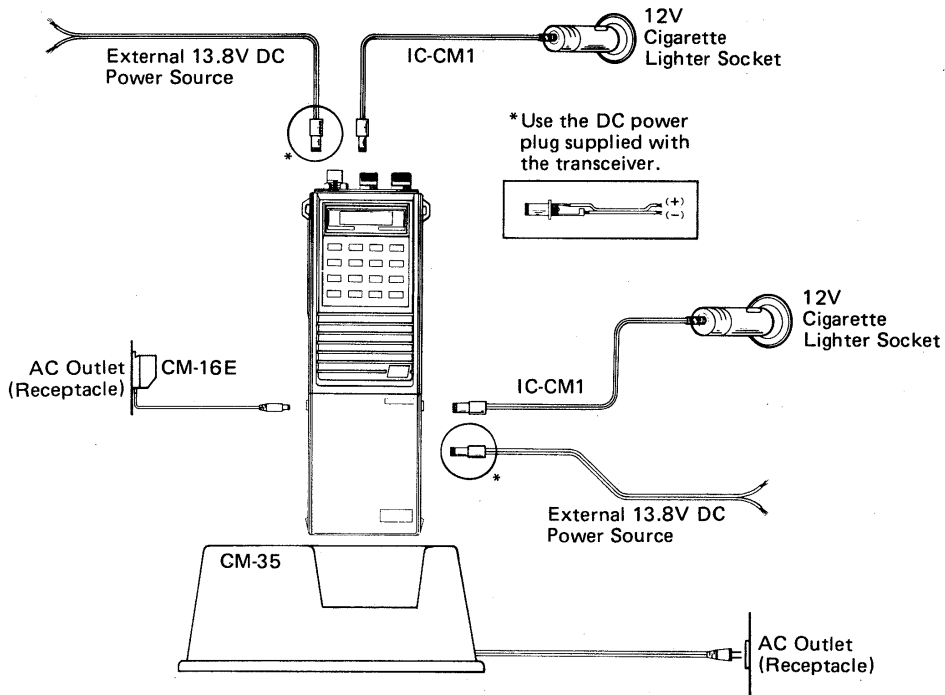

● ANTENNA CONNECTION

Insert the connector on the flexible rubber antenna into the antenna connector on the top of the radio. Screw down securely.

For mobile operation, contact your nearest dealer for a high-performance magnetic mount or clip-on antenna.

● BELT CLIP INSTALLATION

Attach the belt clip to the back panel using the two supplied screws and plastic washers.

● HAND STRAP ATTACHMENT

Spread open and slide the ring of the hand strap over either of the projecting loops on the sides of the transceiver.

● ATTACHMENT OF BELT CLIP AND HAND STRAP

- Attach the belt clip on the back cover with 2 screws supplied.

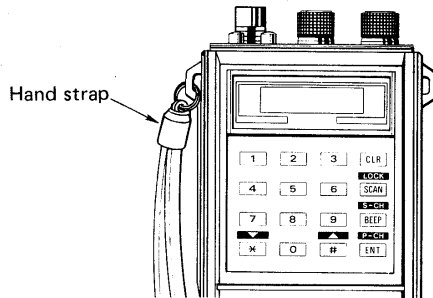
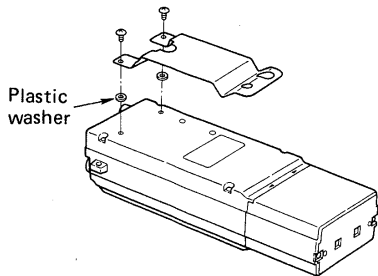

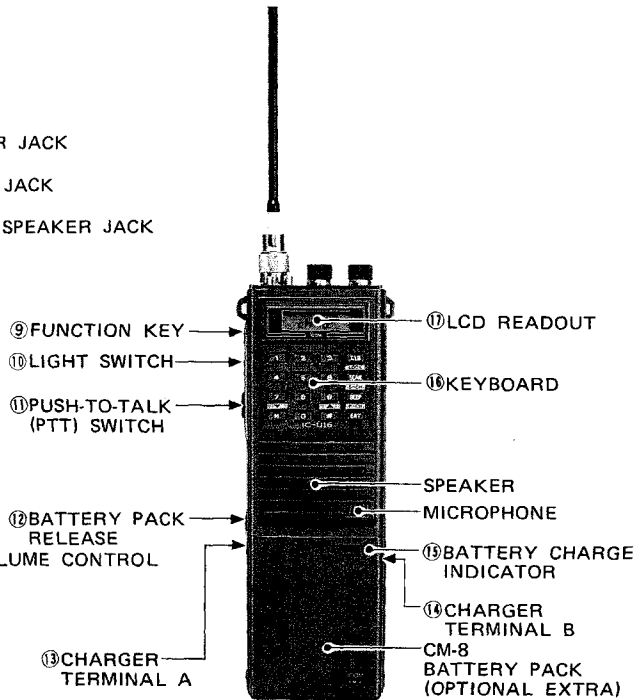
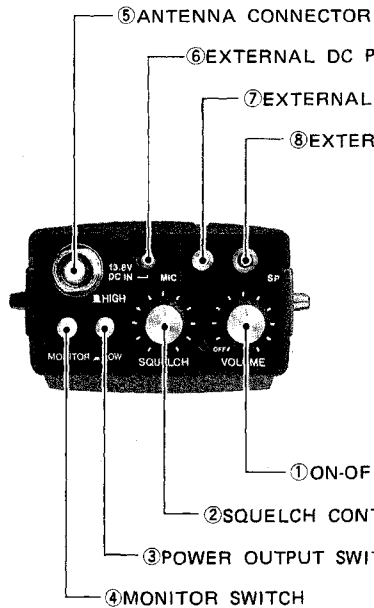

① ON-OFF/VOLUME CONTROL

Rotate clockwise to turn the radio ON and increase the volume level.

Increases the audio level.



② SQUELCH CONTROL

Sets the squelch threshold level. Rotate this control completely counterclockwise to turn OFF the squelch function, and clockwise to raise the threshold level.

Raises the threshold level.



③ POWER OUTPUT SWITCH

When this switch is depressed to the LOW position (IN), the output power is reduced which thus conserves battery life. When greater coverage or longer distance transmissions are needed, place the switch in the HIGH position (OUT) to provide full power.



④ MONITOR SWITCH

Push IN this locking switch in order to override the CTCSS decoder circuit when it is in the mute condition. For normal operation, leave the switch OUT (push again and release).

⑤ ANTENNA CONNECTOR

All antennas connected to the transceiver must be 50Ω and have a TNC plug.

CAUTION: Transmitting without an antenna may damage the transmitter.

⑥ EXTERNAL DC POWER JACK

Connect the IC-CM1 cigarette lighter cable or external 13.8V DC power source to this jack for mobile operation. The battery pack does not need to be installed for operation of the radio, however, if the battery pack is installed, it charges simultaneously.

⑦ EXTERNAL MIC JACK



CM-9

The optional CM-9 or EM-46 SPEAKER-MICROPHONE, optional HS-10 headset can be connected for additional flexibility. (The HS-10 will require the HS-10SA VOX unit or the HS-10SB PTT switch box.) The built-in microphone is not functional when an external microphone is connected.

⑧ EXTERNAL SPEAKER JACK

Connect either an 8Ω external speaker or the supplied earphone for private listening.

⑨ FUNCTION KEY

Push this key to select the secondary function of each key.

⑩ LIGHT SWITCH

Push this switch to turn ON the LCD READOUT light. The light remains ON only while the switch is held in.

⑪ PUSH-TO-TALK (PTT) SWITCH

Push this switch to begin transmitting.

⑫ BATTERY PACK RELEASE BUTTON

Push the release button upwards, and slide the battery pack to the right to remove it from the transceiver.

⑬ CHARGER TERMINAL A

Connect the output plug from the optional CM-16E WALL CHARGER here.

⑭ CHARGER TERMINAL B

Connect the output plug from an external 13.8V DC power source here.

⑮ BATTERY CHARGE INDICATOR

Lights during battery charging with the optional CM-16E WALL CHARGER.

⑯ KEYBOARD

The KEYBOARD has 16 keys consisting of ten numerical keys and six code keys. Some keys have dual functions.

⑰ LCD READOUT

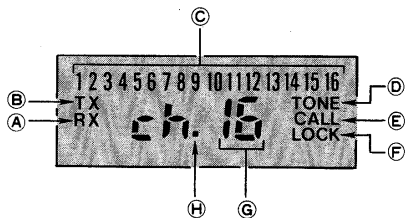

"ch" represents the word "channel"

Ⓐ RECEIVE INDICATOR

"RX" appears when the transceiver is in the receive mode.

Ⓑ TRANSMIT INDICATOR

"TX" appears when the transceiver is in the transmit mode.

Ⓒ SCAN/PRIORITY CHANNEL INDICATOR

The programmed channel numbers "1, 2, 3.....16" appear when the FUNC and BEEP switches are pushed.

Ⓓ TONE INDICATOR

"TONE" appears when the built-in, subaudible tone encoder/decoder is programmed to operate on one of the channels.

Ⓔ CALL INDICATOR

"CALL" appears when a signal is received with the same subaudible tone as is programmed in the transceiver.

Ⓕ LOCK INDICATOR

"LOCK" appears when the KEYBOARD has been deactivated to prevent unwanted keystroke entry.

Ⓖ CHANNEL NUMBER INDICATOR

Displays the operating channel number with 1 or 2 digits.

Ⓗ STEP SCAN INDICATOR

Blinks when the transceiver is scanning in the STEP SCAN.

Verify that the ON-OFF/VOLUME control is in the OFF position before connecting power to the transceiver.

●RECEIVING

- 1) Rotate the ON-OFF/VOLUME control clockwise beyond the "click".

NOTE: The small number at the top of the display indicates the priority channel selected. Also, if the word "TONE" appears on the display, push the MONITOR switch while performing steps 2) and 3).

- 2) Rotate the SQUELCH control fully counterclockwise. Rotate the ON-OFF/VOLUME control clockwise for a comfortable listening level.
- 3) If only noise with no signal is heard from the speaker, rotate the SQUELCH control clockwise until the noise is quieted. This is the threshold point.

The transceiver remains silent after this adjustment until a signal is received which opens the receiver's squelch circuit. If very weak signals are received, the squelch may open and close intermittently. In this case, rotate the SQUELCH control slightly more clockwise until the squelch operates correctly.

- 4) Select the desired channel. If a non-programmed channel is keyed in, this input is rejected and the display automatically reverts back to the previous channel.

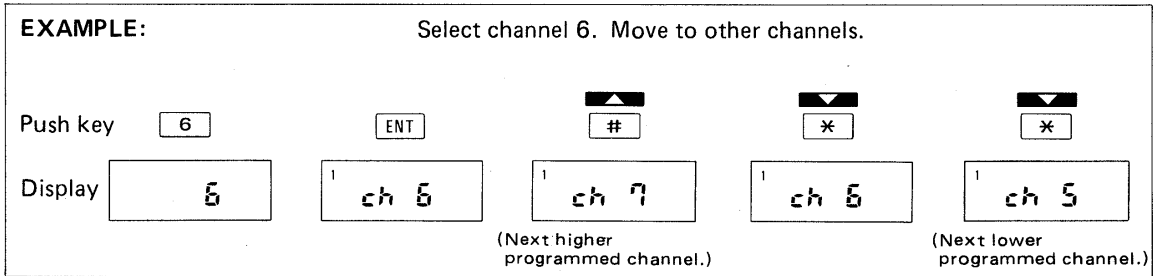



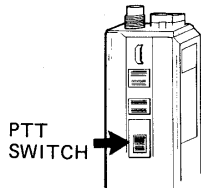









● TRANSMITTING











- 1) Depress the PTT (push-to-talk) switch to begin transmitting. The letters "TX" appear on the display to indicate a signal is being transmitted.
- 2) Speak into the microphone using your normal voice level.
- 3) Release the PTT switch to return to the receive mode.

● KEY FUNCTIONS

Some keys have dual functions. To select the secondary function, push the FUNC key located on the side of the transceiver, and then push the correct key for the function desired.

PRIMARY FUNCTION		SECONDARY FUNCTION	
KEY	FUNCTION	KEY	FUNCTION
	Inputs the digit 1.	-----	-----
	Inputs the digit 2.	-----	-----
	Inputs the digit 3.	-----	-----
	Inputs the digit 4.	-----	-----
	Inputs the digit 5.	-----	-----
	Inputs the digit 6.	-----	-----
	Inputs the digit 7.	-----	-----
	Inputs the digit 8.	-----	-----
	Inputs the digit 9.	-----	-----
	Inputs the digit 0.	-----	-----
 	<p>Decreases the operating channel number.</p> <p>Push the key once to select one channel number lower, or hold the key down to continuously shift downwards through the channels.</p>	-----	-----

PRIMARY FUNCTION		SECONDARY FUNCTION	
KEY	FUNCTION	KEY	FUNCTION
	<p>Increases the operating channel number.</p> <p>Push the key once to select one channel number higher, or hold the key down to continuously shift upwards through the channels.</p>	-----	-----
	<p>Clears the scan function, and stops the scan at the displayed operating channel.</p>	-----	-----
	<p>Starts the scan function.</p> <p>Push this key to scan through all programmed channels.</p>		<p>Disables the keys to prevent accidental key operation.</p> <p>While holding the FUNC key down, push this key to clear the LOCK function.</p>
	<p>A beep tone is generated each time any key is pushed.</p> <p>Push the BEEP key once to turn the beep function ON. Push the key again to turn the function OFF.</p>		<p>Displays the channels to be scanned, and locks out channels not desired in the scanning sequence.</p> <p>While holding the FUNC key down, push this key:</p> <ol style="list-style-type: none"> 1) once to display the scan channels, 2) twice to alternately activate/deactivate the lockout function for the channel currently selected.
	<p>Selects the desired operating channel.</p> <p>Push this key after entering a channel number on the keyboard.</p>		<p>Assigns the most important channel with priority status during the scan.</p>

●PROGRAMMING THE PRIORITY CHANNEL

NOTE: The priority channel cannot be programmed when STEP SCAN has been set in the transceiver. A small number at the top of the LCD READOUT appears when PRIORITY SCAN has been set.

The priority channel feature allows easy monitoring of your most important channel while still listening for signals on the other programmed channels.

- 1) Select an operating channel that you would like as the priority channel.
- 2) Push and hold the FUNC key, and then push the P-CH key. Release the FUNC key.
- 3) The selected operating channel is now the priority channel as indicated by the small number at the top of the display. The priority channel is automatically monitored when PRIORITY SCAN operates.

EXAMPLE:

Program channel 9 as the priority channel.
(previous priority channel was 5.)

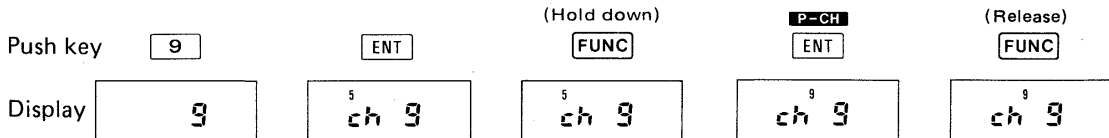

●SCANNING

The IC-H16/IC-U16 provides either **PRIORITY SCAN** or **STEP SCAN**. These scan functions can be set at your nearest authorized ICOM Dealer to suit your operating purposes.

The method of scanning in both **PRIORITY SCAN** and **STEP SCAN** is the same.

- 1) Adjust the **ON-OFF VOLUME** and **SQUELCH** controls as explained on page 20.
 - The **SQUELCH** control must be turned clockwise to close the squelch.
- 2) Push the **SCAN** key to start the scan.
 - Push the **CLR** key to stop the scan.
- 3) See pages 26 and 27 for making a transmission while scanning.

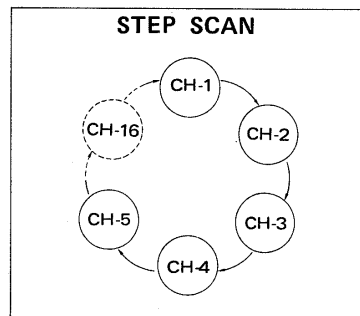
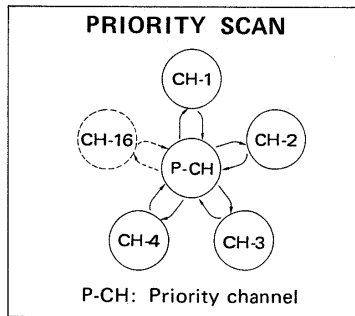

(1) Priority scan

Priority channel number blinks during PRIORITY SCAN.

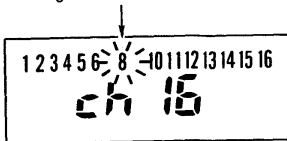

The priority channel feature allows easy monitoring of your most important channel while still listening for signals on the other programmed channels.

1) The small number at the top of the LCD READOUT is the priority channel number. The priority channel can be changed to suit your operating purposes. See page 24.

- The small number at the top of the LCD READOUT blinks during PRIORITY SCAN.

2) The scan stops on a channel while receiving a signal, and starts again after the signal disappears.

3) If you have a call from a station, push the CLR key to cancel scanning on the called channel. Transmitting can be performed on the called channel.

4) When transmitting while the transceiver is scanning, the transmit channel is always the same as the user-programmed priority channel.

- The scan is canceled.

(2) Step scan

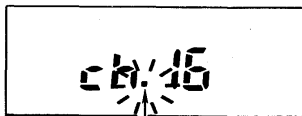

Decimal point blinks during STEP SCAN.

Repeatedly scans the all programmed channels in sequence. The scan will stop at any channel on which a signal is received.

1) The decimal point between the "ch" and channel number on the LCD READOUT blinks during STEP SCAN.

- The IC-H16/IC-U16 provides a function which allows you to selectively choose which channels the scanning function will monitor. See page 28 for more information.

2) The scan stops on a channel that receives a signal, and starts again after the signal disappears.

3) If you have a call from a station, push the PTT switch to cancel scanning on the called channel. Transmitting can be performed on the called channel.

4) When transmitting while the transceiver is scanning, the transmit channel is the same as the channel activated last time.

- The scan is canceled.

●CHANNEL LOCKOUT

This function allows you to selectively choose which channels the scanning function will monitor.

- 1) Select the channel you wish to delete from or add to the scan channels.
- 2) Push and hold the FUNC key, and then push the S-CH key. The display shows all programmed scan channels which are not locked out. Push the S-CH key again to delete or add the channel selected in step 1). Release the FUNC key.

NOTE: The priority channel cannot be locked out.

EXAMPLE:

Lockout channel 14.

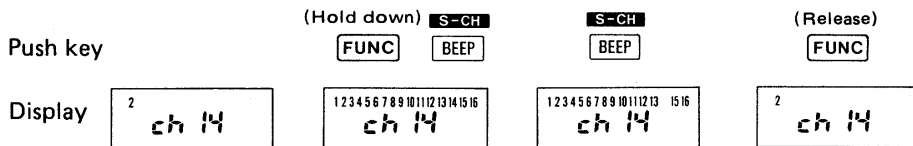

● **KEYBOARD LOCK FUNCTION** This feature prevents accidental changes of the operating channel or other functions selected from the keyboard.

- 1) Push and hold the FUNC key, and then push the LOCK key to activate the function.
- 2) The displayed channel is now locked. All keys on the keyboard are disabled.
- 3) To clear the lock function, push and hold the FUNC key, and then push the LOCK key again.

EXAMPLE: Lock and unlock the keyboard.

Push key	(Hold down) LOCK FUNC SCAN	(Release) FUNC	(Hold down) LOCK FUNC SCAN	(Release) FUNC
Display	⁴ ch 8	⁴ ch 8 LOCK	⁴ ch 8	⁴ ch 8

●DTMF TONE GENERATOR

The front panel keyboard can also be used to generate the tones necessary for accessing a telephone system.

- 1) Push and hold the PTT (Push-To-Talk) switch.
- 2) Use the numbered keys on the keyboard to dial your desired number.

NOTE: After the first key is pushed, the PTT switch may be released. The radio automatically remains in the transmit mode if the keys are depressed successively without pausing.

- 3) The **CLR**, **SCAN**, **BEEP** and **ENT** keys generate the tones associated with the "A", "B", "C" and "D" keys, respectively, on a standard 16-key keyboard.

●POWER SAVER FUNCTION

The IC-H16 and IC-U16 contain a special circuit designed to save battery power when in the receive mode. This circuit begins operating automatically and causes the display to flash ON and OFF.

The power saver function cancels automatically if a signal is received, or if the PTT switch or any keys on the keyboard are pushed.

SECTION 5 GENERAL SPECIFICATIONS

	IC-H16/IC-U16	IC-U2
• CHANNEL SPACING :	12.5kHz	12.5kHz
• NUMBER OF CHANNELS :	16	2
• COMPLIANCE :	MPT 1301	MPT 1301
• APPROVED NUMBER :	RTD3195 (IC-H16) RTD3282 (IC-U16)	RTD3386
• AF POWER OUTPUT :	0.5W	0.5W
• RF POWER OUTPUT :	SEE TABLE ON PAGE 32	SEE TABLE ON PAGE 32

● BATTERY PACK SPECIFICATIONS

BATTERY PACK MODEL	HEIGHT	CHARGER REQUIRED	OUTPUT VOLTAGE (V)	TYPICAL OUTPUT (IN WATTS)	REPLACEABLE BATTERIES	NOTES
CM-2	39mm 1.6 inch	CM-35	7.2	2.0	No	Low power/Quick charge (1.5hr.) Long life/Overcharge protected.
CM-3	39mm 1.6 inch	CM-25E or CM-35	8.4	3.0	No	Standard power/Standard charge (15hr.).
CM-5	60mm 2.5 inch	CM-35	10.8	4.0	No	Medium power/Long life Quick charge (1.5hr.)/ Overcharge protected.
CM-5A	79.5mm 3.2 inch	CM-16E or CM-35	10.8	4.0	No	Medium power/Quick charge (1.5hr.)/Overcharge protected or Slow charge.
CM-7	79.5mm 3.2 inch	CM-16E or CM-35	13.8	5.0	No	High power/Quick or slow charge.
CM-8	79.5mm 3.2 inch	CM-16E or CM-35	8.4	3.0	No	Standard power/Long life (800mAH).

SECTION 6 ACCESSORIES (OPTIONAL)

- **IC-CM1
CIGARETTE LIGHTER CABLE** Plugs into cigarette lighter socket to charge CM-3, CM-5A, CM-7 or CM-8, or to operate unit from car battery.
- **CM-4 BATTERY CASE** For AA size NiCd or dry batteries.
- **CM-35
AC BATTERY CHARGER** Charges all ICOM battery packs. Charges CM-3 in 15 hours, CM-2, CM-5, CM-5A and CM-7 in 1.5 hours fast, and the CM-8 in 3 hours.
- **CM-9, EM-46
SPEAKER-MICROPHONE** Plugs into transceiver and clips on lapel or pocket. Has PTT switch.
- **CARRYING CASES** High quality cases to protect your transceiver available.
- **CM-16E WALL CHARGER** Charges CM-5A, CM-7 and CM-8.
- **CM-25E WALL CHARGER** Charges CM-3 BATTERY PACK.
- **HS-10 HEADSET** With boom microphone for all ICOM portables (Requires HS-10SA or HS-10SB).
- **HS-10SA VOX UNIT** To be used with HS-10, for IC-H16, IC-U16 and IC-U2.
- **HS-10SB PTT SWITCH BOX** To be used with HS-10.

Count on us!

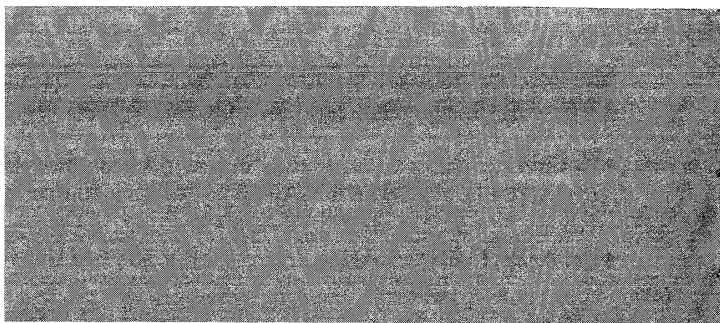

Icom (UK) Ltd.

Unit 9, Sea St., Herne Bay, Kent, U.K.

Phone : 0227 363859

Fax : 0227 360155

Telex : 965179 ICOM G

A-0901-N

Printed in Japan

Copyright © 1988 by Icom Inc.

Icom Inc.

6-9-16, Kamihigashi, Hirano-ku, Osaka 547, Japan
